

B50 SINGLE ROW FEMALE HEADER SMT (H: 8.5mm)

PITCH: 2.54mm

SPECIFICATIONS

Material

Insulator : LCP, glass reinforced, rated UL 94V-0
 Contact : Phosphor Bronze

Electrical

Current Rating : 1 Amp
 Contact Resistance : 30 mΩ max.
 Insulation Resistance : 3000 MΩ min.
 Dielectric Withstanding Voltage : 500V AC for 1minute
 Operating Temperature : -40°C to +105°C
 ► Mating Suggestion : C15, C16, C19 & C23 series.

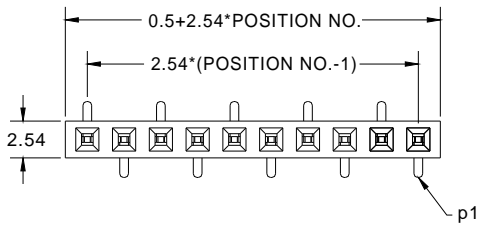
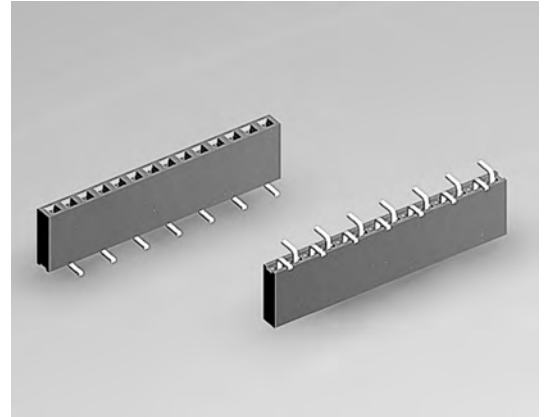

(TYPE A)

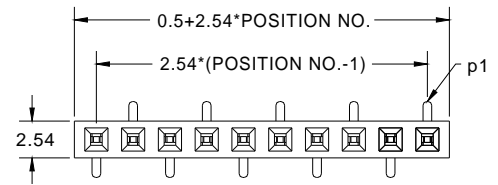
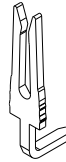

(TYPE B)

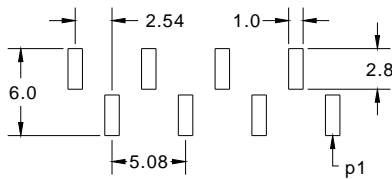
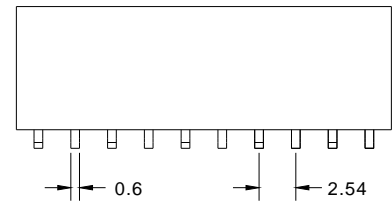
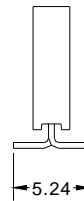
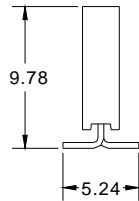
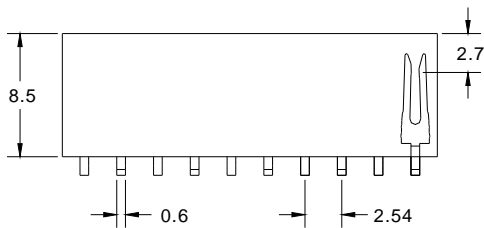

RECOMMENDED P.C.B. LAYOUT

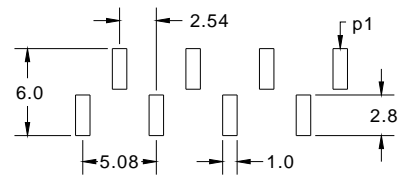

RECOMMENDED P.C.B. LAYOUT

How to order: B50 - 1 - 2 - 3 - 4 - 5 - 6 - G(RoHS)

1.NO. OF CONTACT	2.CONTACT MATERIAL	3.CONTACT PLATING	4.FOOT RANK TYPE	5.PACKAGING	6.INSULATOR COLOR
SINGLE ROW 1*2 - 1*40	B: PHOSPHOR BRONZE	T: TIN PLATED S: SELECTIVE G: GOLD FLASH A: 5u" INCH GOLD B: 10u" INCH GOLD C: 15u" INCH GOLD D: 30u" INCH GOLD	A: TYPE A B: TYPE B	A:TUBE WITH PAD B: TUBE W/O PAD C: TAPE & REEL WITH PAD	1. BLACK



DON CONNEX
ELECTRONICS CO., LTD

T:886 2 86483356 | F:886 2 86485885
e-mail: info@donconnex.com.tw



Connector:E163339 | Flat cable:E162690
Wiring Harnesses:E312257