

# C01b SHROUDED HEADER STR WITH STEEL SWIN-LOCK

**PITCH: 2.54mm \* 2.54mm**

## SPECIFICATIONS

### Material

Insulator : PBT, glass reinforced, rated UL 94V-0

Contact : Brass

### Electrical

Current Rating : 2 Amp

Contact Resistance : 30 mΩ max.

Insulation Resistance : 3000 MΩ min.

Dielectric Withstanding Voltage : 500V AC for 1minute

Operating Temperature : -40°C to +105°C

► Mating Suggestion : A01, A01e, A03a, A03b & A35 series.

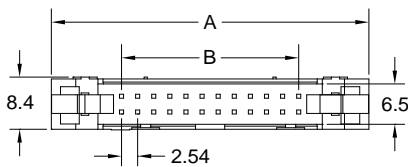
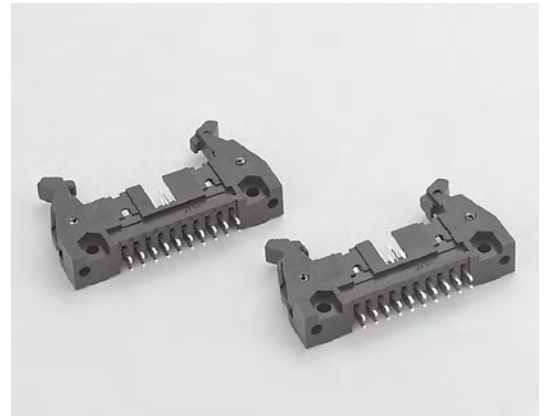

ACCESSORIES	X	Y
LONG LATCH	26.3	14.6
SHORT LATCH	24.7	10.6

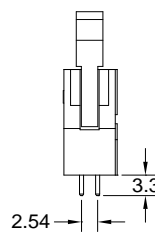
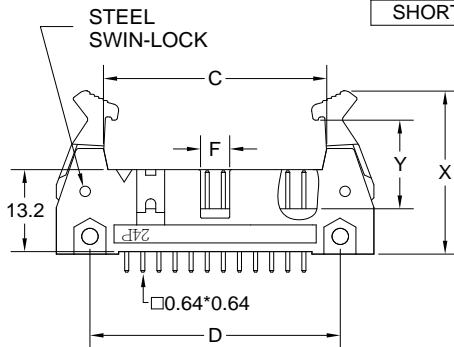

POSITION	A	B	C	D	E	F
6	27.16	5.08	12.77	16.49	22.44	2.9
8	29.70	7.62	15.31	19.03	24.98	2.9
10	32.24	10.16	17.85	21.57	27.52	4.6
12	34.78	12.70	20.39	24.11	30.06	4.6
14	37.32	15.24	22.93	26.65	32.60	4.6
16	39.86	17.78	25.47	29.19	35.14	4.6
20	44.94	22.86	30.55	34.27	40.22	4.6
24	50.02	27.94	35.63	39.35	45.30	4.6
26	52.56	30.48	38.17	41.89	47.84	4.6
30	57.64	35.56	43.25	46.97	52.92	4.6
34	62.72	40.64	48.33	52.05	58.00	4.6
40	70.34	48.26	55.95	59.67	65.62	4.6
44	75.42	53.34	61.03	64.75	70.70	4.6
50	83.04	60.96	68.65	72.37	78.32	4.6
60	95.74	73.66	81.35	85.07	91.02	4.6
64	100.82	78.74	86.43	90.15	96.10	4.6

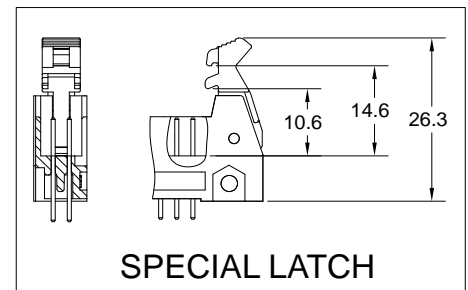
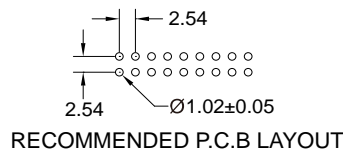
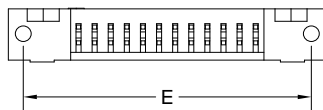

**SPECIAL LATCH**

**How to order:** C01b - 1 - 2 - 3 - 4 - 5 - G(RoHS)

1.NO. OF CONTACT	2.CONTACT MATERIAL	3.CONTACT PLATING	4.ACCESSORIES	5.INSULATOR COLOR
06 08 10 12 14 16 20 24 26 30 34 40 44 50 60 64	A: BRASS	T: TIN PLATED S: SELECTIVE G: GOLD FLASH A: 5u" INCH GOLD B: 10u" INCH GOLD C: 15u" INCH GOLD D: 30u" INCH GOLD	A: LONG LATCH B: SHORT LATCH C: SPECIAL LATCH	1. BLACK 2. GREY



**DON CONNEX**  
ELECTRONICS CO., LTD

T:886 2 86483356 | F:886 2 86485885  
e-mail:info@donconnex.com.tw



Connector:E163339 | Flat cable:E162690  
Wiring Harnesses:E312257

